

wright flow

TECHNOLOGIES[®]

HYGIENIC PUMP SOLUTIONS

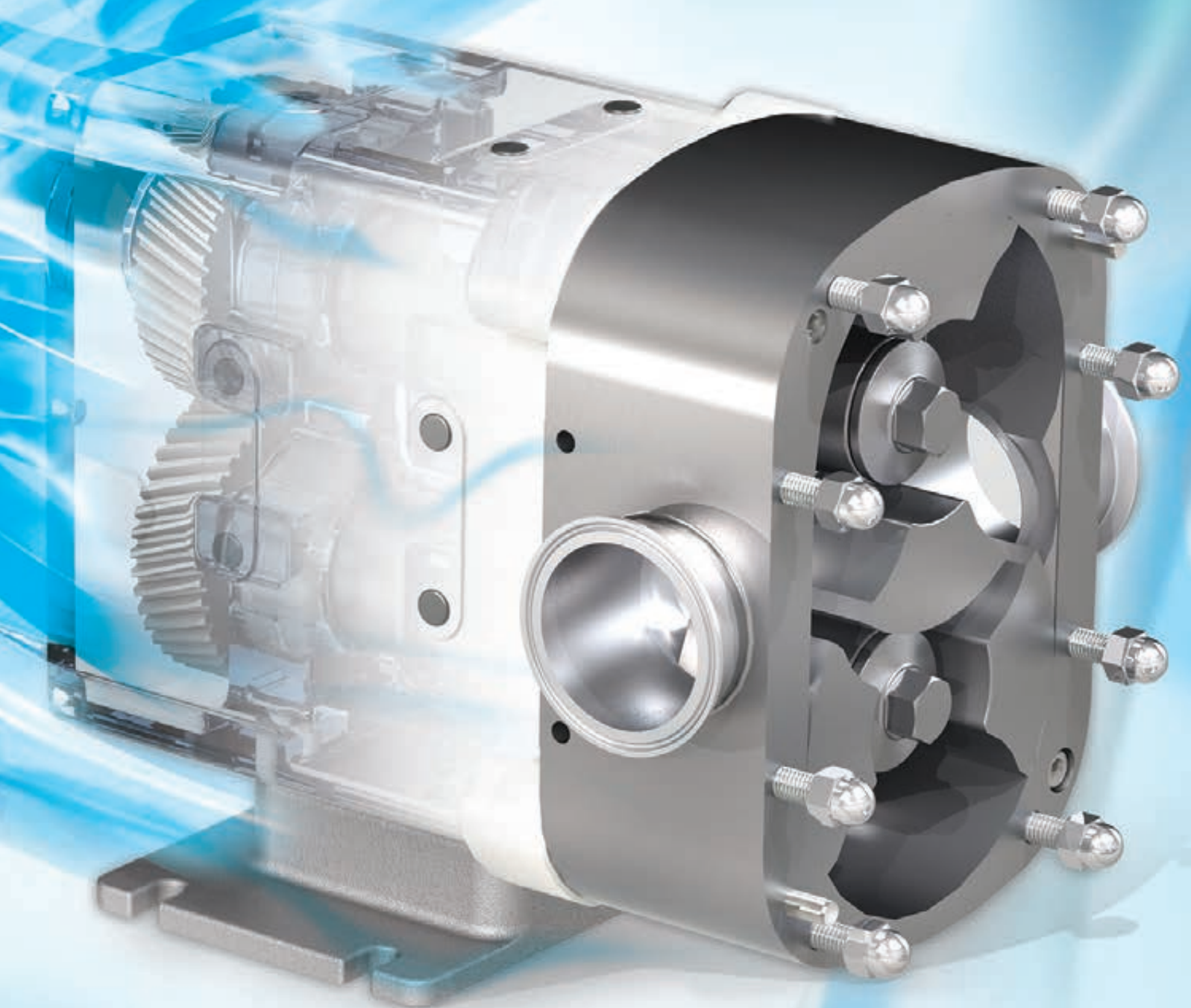

PRODUCT CATALOG
WRIGHTFLOWTECHNOLOGIES.COM

IBEX

wright flow

TECHNOLOGIES[®]

HYGIENIC PUMP SOLUTIONS



YOUR COMPLETE Hygienic Solutions Provider



Around the world, Wright Flow Technologies provides solutions for challenges in fluid handling. You can count on the reliability of Wright Flow hygienic positive displacement (PD) pumps. Matching the right pump with your fluid processing needs is easy with innovative, robust designs, cleanability & an extensive product offering.

As a key partner for modern high-tech process industries of today, Wright Flow Technologies delivers solutions across a wide range of viscosities. From gentle action on shear sensitive liquids, or slurries with soft solids, to demanding abrasive media, Wright Flow pumps get the job done.

- GLOBAL PRESENCE WITH LOCALIZED SERVICE
- BROADEST PD PUMP OFFERING IN THE INDUSTRY
- COMPLETE PARTNER FOR YOUR HYGIENIC PROCESS

Revolution

SteriLabe

CONCEPT SQ

TRA20SERIES

classic+

rtp

TRA10SERIES

MultiPump



Quickly link to more information throughout this catalog by scanning the QR icons with your smartphone.



CATALOG CONTENTS

ABOUT US
PAGE 2

APPLICATIONS
PAGE 4

PUMP LINE-UP
PAGE 8

CIRCUMFERENTIAL PISTON
PAGE 10

ROTARY LOBE
PAGE 18

COMPLETE UNITS
PAGE 30

PARTS & SERVICE
PAGE 32

REMANUFACTURING
PAGE 32

PUMP SELECTION GUIDE
PAGE 34



CHEMICAL
Raw Ingredients, Chemical Transfer, Solvent Recovery



PERSONAL CARE
Skin Care Products, Toothpastes, Cosmetics, Shower & Shaving Liquids, Hair Care Products



BEVERAGES
Distillers & Vinters, Fruit & Vegetable Purees, Carbonated Drinks, Juices



FOOD
Baby Food, Edible Oils, Soft Fruits & Vegetables, Soups & Sauces, Egg, Fish, Meat, Poultry, Whey Proteins, Confectionary



DAIRY
Butter, Cheese, Cream, Milk, Yogurt, Yogurt Fruits



PHARMACEUTICAL
Medicinal Chemicals, Creams & Ointments, Syrups, Injectables, Ultra Filtration, Blood & Plasma Processing

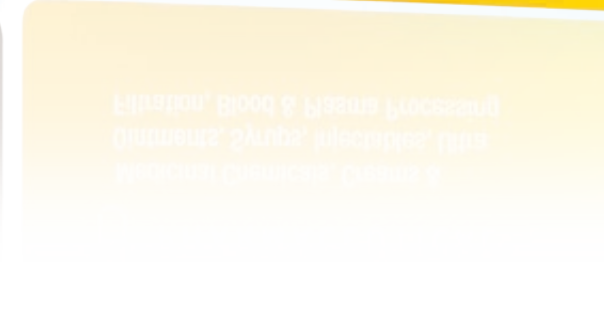

 **CLEANABILITY**

- Clean Out of Place (COP), Clean In Place (CIP) & Sterilize-In-Place (SIP) options available
- Innovative designs compatible with the most stringent hygienic requirements

 **PERFORMANCE**

- Leading flow performance & efficiency in low & high viscosity applications
- Robust designs for long-life durability

 **EASE OF MAINTENANCE**

- Smooth running planned downtime procedures get production lines up & running quickly
- Features include front-loading seals, up front shimming, cartridge shaft assemblies & many more

 **TOTAL COST OF OWNERSHIP**

- Ease of Maintenance + Cleanability + Performance = Reduced Total Cost of Ownership
- Wright Flow Technologies continuously seeks to save you time & optimize your facility resources



LEARN MORE ONLINE
WRIGHTFLOWTECHNOLOGIES.COM/APPLICATIONS



Revolution[®] Increase Your Expectations

- ✦ Ease of Maintenance
- ✦ Exceptional Cleanability
- ✦ The Benefits of Both CPP & Lobe

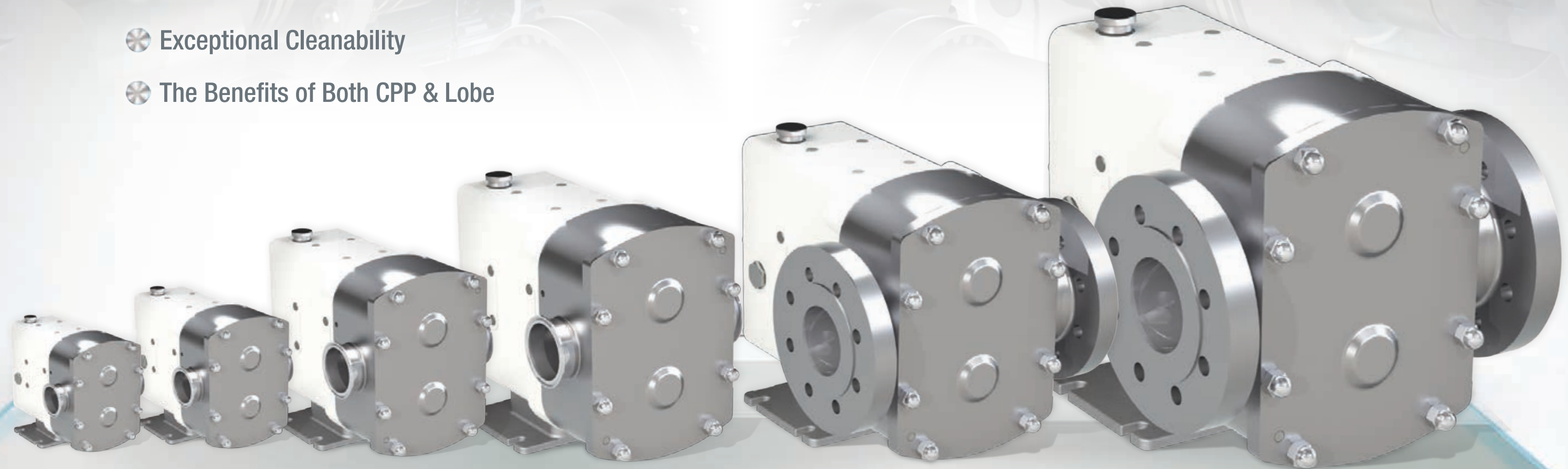

STANDARD
PORT SIZES

FRAME 2
1.5 in. (38.1 mm)

FRAME 3
1.5 or 2 in. (38.1 or 50.8 mm)

FRAME 4
2, 2.5 or 3 in. (50.8, 63.5 or 76.2 mm)

FRAME 5
3 or 4 in. (76.2 or 101.6 mm)

FRAME 6
4 or 6 in. (101.6 or 152.4 mm)

FRAME 7
6 or 8 in. (152.4 or 203.2 mm)

[LEARN MORE](#)

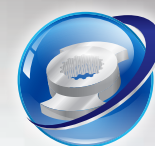

CPP: Page 12



Lobe: Page 22



CIRCUMFERENTIAL PISTON PUMPS



Revolution

- 17 Displacements
- Capacity: to 190 m³/hr / 836 USGPM
- Pressure: to 31 BAR / 450 PSI



P.12



TRA20SERIES

- 11 Displacements
- Capacity: to 102 m³/hr / 450 USGPM
- Pressure: to 34 BAR / 500 PSI



P.14

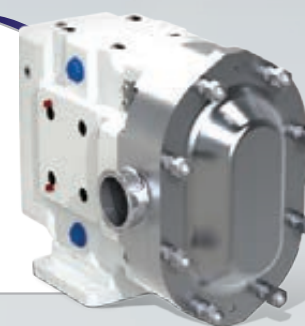

TRA10SERIES

- 9 Displacements
- Capacity: to 102 m³/hr / 450 USGPM
- Pressure: to 27 BAR / 400 PSI



P.16

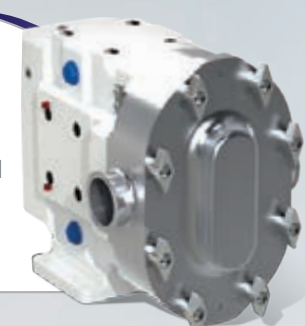

ROTARY LOBE PUMPS



SteriLobe

- 14 Displacements
- Capacity: to 171 m³/hr / 753 USGPM
- Pressure: to 15 BAR / 218 PSI



P.20

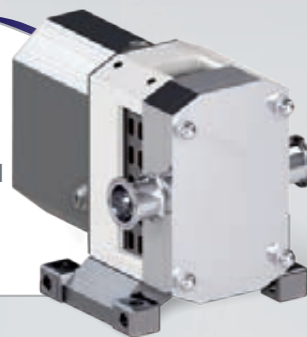

Revolution

- 11 Displacements
- Capacity: to 76 m³/hr / 333 USGPM
- Pressure: to 15 BAR / 218 PSI



P.22

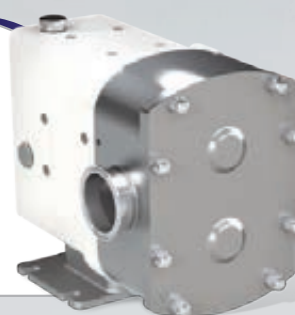

classic+ MultiPump

- 11 Displacements
- Capacity: to 189 m³/hr / 832 USGPM
- Pressure: to 12 BAR / 174 PSI



P.24

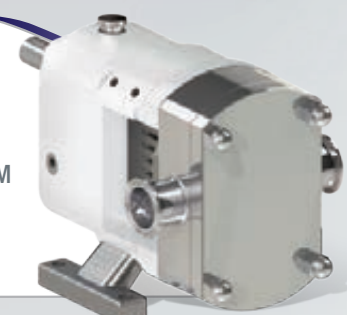

rtp

- 2 Displacements
- Capacity: to 76 m³/hr / 338 USGPM
- Pressure: to 12 BAR / 174 PSI



P.26



CONCEPT SQ

- 8 Displacements
- Capacity: to 109 m³/hr / 480 USGPM
- Pressure: to 15 BAR / 218 PSI



P.28

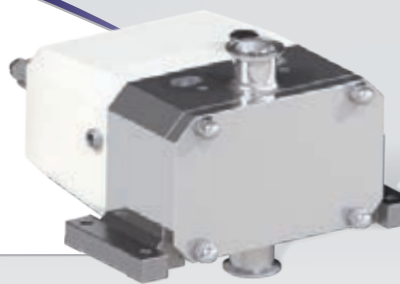

LEARN MORE ONLINE
WRIGHTFLOWTECHNOLOGIES.COM/PRODUCTS

CIRCUMFERENTIAL PISTON PUMPS (CPP)

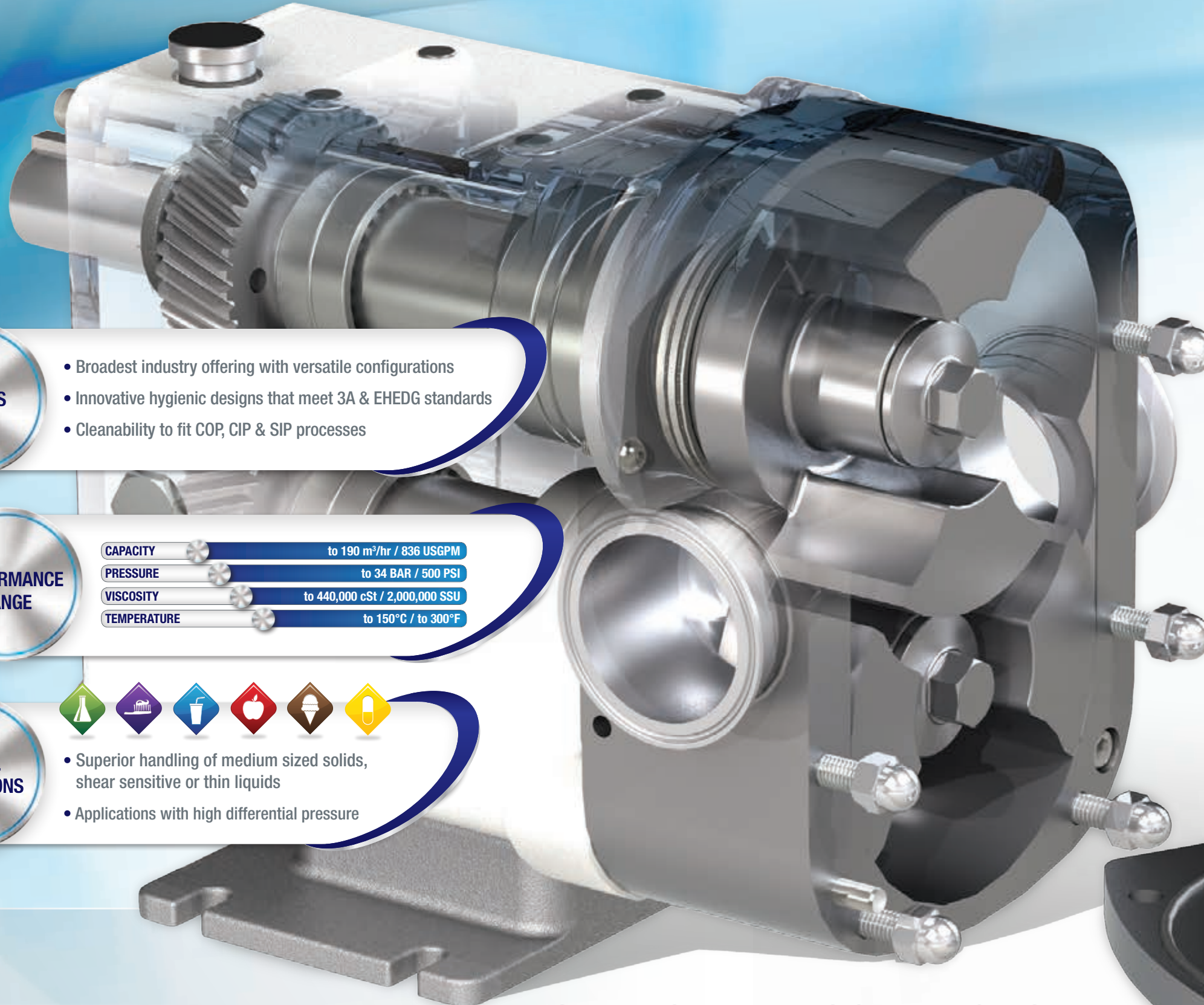

CPP PRODUCTS:

P.12
REVOLUTION®



P.14
TRA20



P.16
TRA10

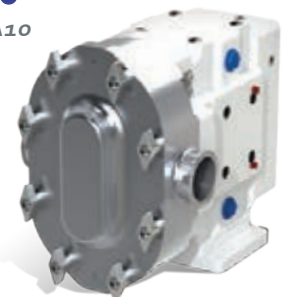

BENEFITS

- Broadest industry offering with versatile configurations
- Innovative hygienic designs that meet 3A & EHEDG standards
- Cleanability to fit COP, CIP & SIP processes

PERFORMANCE RANGE

CAPACITY	to 190 m ³ /hr / 836 USGPM
PRESSURE	to 34 BAR / 500 PSI
VISCOSITY	to 440,000 cSt / 2,000,000 SSU
TEMPERATURE	to 150°C / to 300°F

TYPICAL APPLICATIONS



- Superior handling of medium sized solids, shear sensitive or thin liquids
- Applications with high differential pressure



CPP PUMPS



Revolution®

Raise the bar on performance & ease of maintenance with the Revolution. Revolution has the most advanced design in the CPP industry, with CIP as standard without compromising efficiency. It is the only pump available with patented hybrid technology, allowing CP or RL configurations.



CLEANABILITY

- Efficient CIP (Clean In Place) ability is standard for all Revolution pumps
- Self draining pump head from innovative cusps & cusp reliefs
- Innovative seal design with no dead zones & a dynamic leak path
- No dead zones on front cover

EASE OF MAINTENANCE

- Fast, front loading seal changes while pump is still in line
- Easy front access shimming for setting rotor clearance

PERFORMANCE

- Improved volumetric efficiency in low & high viscosity applications
- Up to 15% better flow performance than competitors' CIP configuration
- Exclusive, non-galling WFT 808® alloy rotors standard; permits running at tighter clearances
- Long-life durability from heavy duty shafts, bearings & helical gears

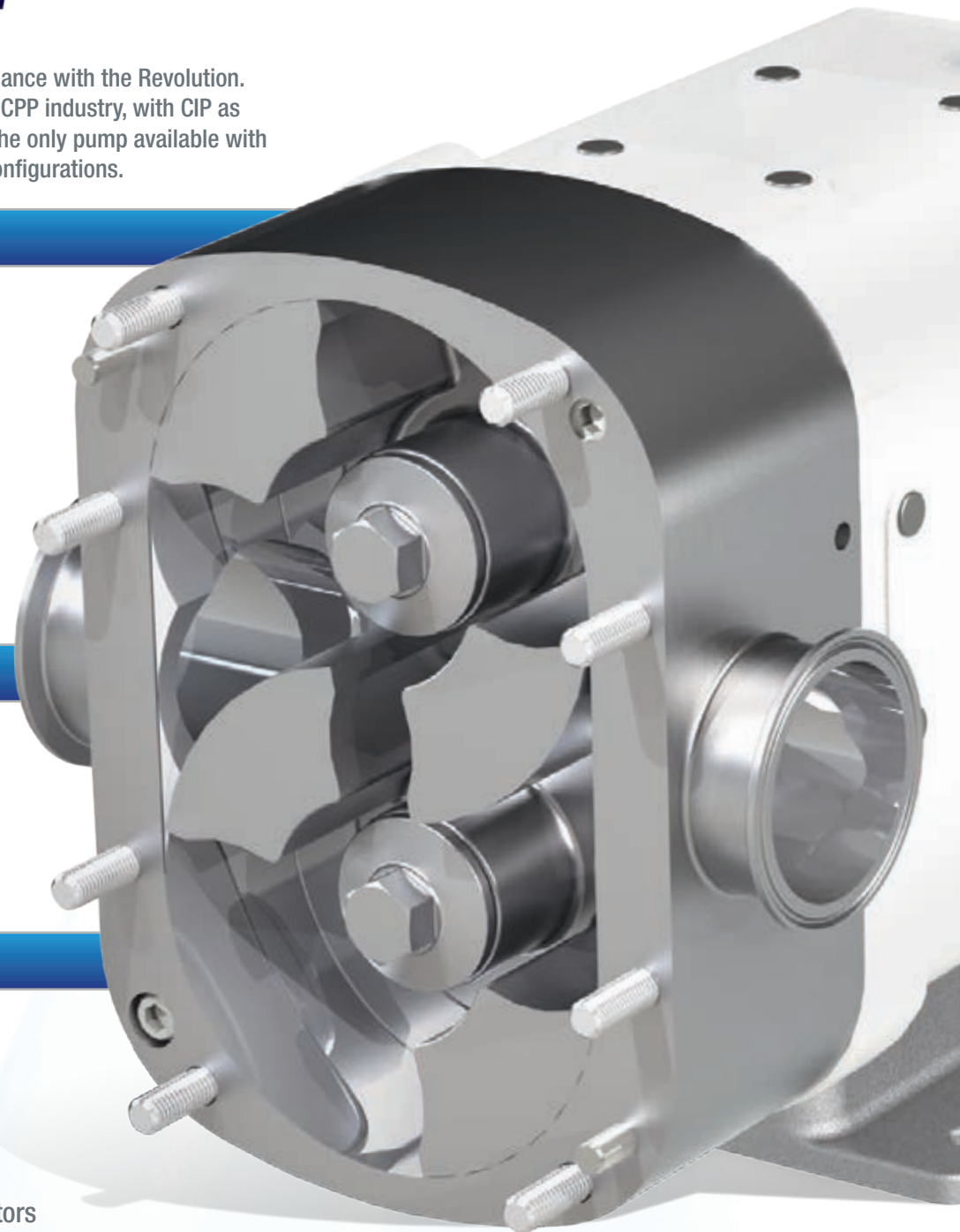

PERFORMANCE RANGE:

- CAPACITY** to 190 m³/hr / 836 USGPM
- PRESSURE** to 31 BAR / 450 PSI
- VISCOSITY** to 440,000 cSt / 2,000,000 SSU
- TEMPERATURE** to 150°C / 300°F

PORTING OPTIONS:

- Hygienic port options: Tri-clamp, DIN 11864, DIN 11851 Male, SMS Male, I-Line
- Industrial port options: ASA/ANSI 150 lb. or 300 lb. RF, DIN 2633, BSP Male, NPT Male
- Rectangular flange/hopper inlet available on select sizes

SEAL OPTIONS:

- Single mechanical
- Double mechanical with flush
- Complete range of material options
- Single O-ring
- Double O-ring with flush

GEARBOX OPTIONS:

- Powder-coated cast iron standard
- Stainless steel optional
- Oil lubrication standard, grease optional

ROTOR & CASING OPTIONS:

- 316L stainless steel pump casing with interior finished to Ra of 32µm (0.8µm)
- Non-galling WFT 808® nickel alloy rotors standard; 316L SS optional
- Optional clearances: front face, hot, high temperature/high viscosity (chocolate) clearances available
- Pumps may be fitted with front cover & rotor case jackets when required



Size	Revolution CPP Model	Displacement		Max Pressure		Max Speed	Standard Ports		Max Capacity		Max Temperature	
		l/rev.	USG/rev.	BAR	PSI	RPM	mm	in.	m³/hr	USG/min.	Deg. C	Deg. F
2	R0150X	0.055	0.014	21	305	800	38.1	1.5	2.6	11	150	300
	R0180P	0.11	0.029	14	203	800	38.1	1.5	5.3	23	150	300
3	R0200X	0.16	0.04	21	305	800	38.1	1.5	8	34	150	300
	R0300X	0.23	0.06	17	247	800	38.1	1.5	11	48	150	300
	R0400X	0.29	0.08	14	203	800	50.8	2	14	62	150	300
	R0450X	0.42	0.1	31	450	600	50.8	2	15	67	150	300
4	R0600P	0.58	0.2	21	305	600	63.5	2.5	21	92	150	300
	R0800X	0.77	0.2	17	247	600	63.5	2.5	28	122	150	300
	R1300X	1	0.3	14	203	600	76.2	3	36	159	150	300
	R1800X, R1830X	1.46	0.4	31	450	600	76.2	3	53	231	150	300
5	R2200X, R2230X	1.98	0.5	21	305	600	101.6	4	71	313	150	300
	R2600P, R2630P	2.52	0.7	14	203	600	101.6	4	91	399	150	300
	R3200P, R3230P	3	0.800	21	305	600	152.4	6	108	476	150	300
6	R3800P, R3830P	3.80	1	14	203	600	152.4	6	138	606	150	300
	R3900P, R3930P	4.80	1.30	8	116	600	152.4	6	173	761	150	300
7	R4200P, R4230P	6.20	1.60	28	400	400	152.4	6	148	652	150	300
	R5200P, R5230P	9	2.40	14	200	350	203.2	8	190	836	150	300

Size	Revolution Rectangular Flange Model	Displacement		Max Pressure		Max Speed	Inlet (WxL)		Outlet		Max Capacity		Max Temperature	
		l/rev.	USG/rev.	BAR	PSI	RPM	mm	in.	mm	in.	m³/hr	USGPM	Deg. C	Deg. F
3	0340	0.23	0.06	17	247	800	47 x 173	1.85 x 6.81	50.8	2	11	48	150	300
4	0640	0.58	0.2	21	305	600	60 x 226	2.36 x 8.90	63.5	2.5	21	92	150	300
	1340	1	0.3	14	203	600	81 x 236	3.19 x 9.29	76.2	3	36	159	150	300
5	2240	1.98	0.5	21	305	600	103 x 285	4.06 x 11.22	101.6	4	71	313	150	300

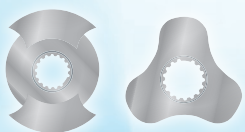

COMPLIANT WITH THE FOLLOWING STANDARDS



TRA20SERIES

The TRA20 Series pumps can be built for CIP processing environments with added options, with internal design to allow vigorous flushing through all internal chambers. A very robust performer, the TRA20 Series pumps allow the highest pressure capabilities in the Wright Flow line.



CLEANABILITY

- CIP (Clean In Place) design optional
- Free draining cover with flat body profile option
- Sealed shaft with o-ring on rotor & rotor nut

PERFORMANCE

- Efficient handling for low & high viscosity applications
- Exclusive, non-galling WFT 808® alloy rotors standard; permits running at tighter clearances
- High strength 17-4 PH single piece shaft standard
- Improved load carrying capabilities

EASE OF MAINTENANCE

- Drop-in-place with TRA10 & comparable manufacturer models
- Interchangeable service parts with comparable manufacturer models
- Stainless steel bearing retainers standard, prevent rusting



PERFORMANCE RANGE:

CAPACITY	to 102 m ³ /hr / 450 USGPM
PRESSURE	to 34 BAR / 500 PSI
VISCOSITY	to 200,000 cSt / 910,000 SSU
TEMPERATURE	to 150°C / 300°F

PORTING OPTIONS:

- Complete range of hygienic clamp, screw, flange & industrial screw connections
- Tri-clamp, flanged, DIN, IMDA, NPT, BSP, etc.

SEAL OPTIONS:

- Single mechanical
- Double mechanical with flush
- Complete range of material options

GEARBOX OPTIONS:

- Powder-coated standard
- 304 stainless steel optional

ROTOR & CASING OPTIONS:

- 316 stainless steel pump casing with interior finished to Ra of 32µin (0.8µm)
- Non-galling WFT 808® nickel alloy rotors standard
- Optional clearances: front face, hot, high temperature/high viscosity (chocolate)
- Clean In Place (CIP) & flat body profile available
- Twin wing rotors standard; single wing available



TRA20 Model	Displacement		Max Pressure		Max Speed	Standard Ports		Max Capacity		Max Temperature	
	l/rev.	USG/rev.	BAR	PSI	RPM	mm	in.	m ³ /hr	USGPM	Deg. C	Deg. F
0060	0.03	0.008	21	300	1000	25.4	1	1.8	8	150	300
0150	0.052	0.014	17	250	800	38	1.5	2.5	11	150	300
0180	0.108	0.029	14	200	700	38	1.5	4.5	20	150	300
0300	0.227	0.06	17	250	600	38	1.5	8.2	36	150	300
0450	0.366	0.096	31	450	600	51	2	13.2	58	150	300
0600	0.568	0.15	21	300	600	64	2.5	20.4	90	150	300
1300	0.946	0.25	14	200	600	76	3	34.1	150	150	300
1800	1.45	0.383	31	450	600	76	3	52.2	230	150	300
2100	1.89	0.5	34	500	600	102	4	68.1	300	150	300
2200	1.95	0.516	21	300	600	102	4	70.4	310	150	300
3200	2.85	0.75	21	300	600	152	6	102	450	150	300

TRA20 Rectangular Flange Model	Displacement		Max Pressure		Max Speed	Inlet (WxL)		Outlet		Max Capacity		Max Temperature	
	l/rev.	USG/rev.	BAR	PSI	RPM	mm	in.	mm	in.	m ³ /hr	USGPM	Deg. C	Deg. F
0340	0.23	0.06	14	200	400	44.50 x 171.45	1.75 x 6.75	38.1	1.5	5.4	24	150	300
0640	0.57	0.15	14	200	400	56.90 x 224.03	2.24 x 8.82	57.15	2.5	13.6	60	150	300
1340	0.95	0.25	14	200	400	75.44 x 234.95	2.97 x 9.25	76.2	3	22.7	100	150	300
2240	1.95	0.52	14	200	400	98.30 x 279.40	3.87 x 11.00	101.6	4	45.4	200	150	300

Note: Hot clearances required for high temperature operation.

COMPLIANT WITH THE FOLLOWING STANDARDS





TRA10 SERIES

Designed for easy strip cleaning, the TRA10 series is the ideal choice for COP processing environments. The pump casing is independently fastened to the gearbox to prevent damage to the seals when the cover is removed & to allow the rotors to be turned while spraying down the fluid chamber.



CLEANABILITY

- Easy disassembly for easy COP (Clean Out of Place)
- Designed to 3A standards

PERFORMANCE

- Efficient handling for low & high viscosity applications
- Exclusive, non-galling WFT 808[®] alloy rotors standard; permits running at tighter clearances
- High strength 17-4 PH single piece shaft standard on 0300 and larger
- Helical gears, improving load carrying capabilities

EASE OF MAINTENANCE

- Drop-in-place with TRA20 & comparable manufacturer models
- Interchangeable service parts with comparable manufacturer models
- Easy disassembly



PERFORMANCE RANGE:

- CAPACITY** to 102 m³/hr / 450 USGPM
- PRESSURE** to 27 BAR / 400 PSI
- VISCOSITY** to 200,000 cSt / 910,000 SSU
- TEMPERATURE** to 150°C / 300°F

PORTING OPTIONS:

- Complete range of hygienic clamp, screw, flange & industrial screw connections
- Tri-clamp, flanged, DIN, IMDA, NPT, BSP, etc.

SEAL OPTIONS:

- Single O-ring
- Double O-ring with flush
- Single mechanical
- Double mechanical with flush
- Complete range of material options

GEARBOX OPTIONS:

- Powder-coated standard
- 304 stainless steel optional

ROTOR & CASING OPTIONS:

- 316 stainless steel pump casing with interior finished to Ra of 32µin (0.8µm)
- Non-galling WFT 808[®] nickel alloy rotors standard; 316 SS optional
- Optional clearances: front face, hot, high temperature/high viscosity (chocolate)

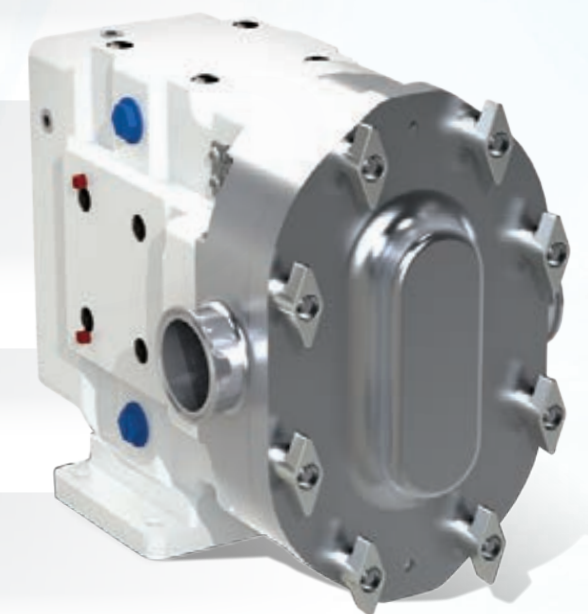

TRA10 Model	Displacement		Max Pressure		Max Speed RPM	Standard Ports		Max Capacity		Max Temperature	
	l/rev.	USG/rev.	BAR	PSI		mm	in.	m ³ /hr	USGPM	Deg. C	Deg. F
0060	0.03	0.008	14	200	800	38	1.5	1.3	6	150	300
0150	0.052	0.014	14	200	700	38	1.5	2	9	150	300
0180	0.11	0.03	14	200	600	38	1.5	3.8	17	150	300
0300	0.23	0.06	14	200	600	38	1.5	8.2	36	150	300
0450	0.38	0.1	27	400	600	51	2	13.3	59	150	300
0600	0.58	0.15	14	200	600	64	2.5	20.4	90	150	300
1300	0.96	0.25	14	200	600	76	3	34.1	150	150	300
2200	1.98	0.52	14	200	600	102	4	70.4	310	150	300
3200	2.85	0.75	14	200	600	152	6	102	450	150	300

TRA10 Rectangular Flange Model	Displacement		Max Pressure		Max Speed RPM	Inlet (WxL)		Outlet		Max Capacity		Max Temperature	
	l/rev.	USG/rev.	BAR	PSI		mm	in.	mm	in.	m ³ /hr	USGPM	Deg. C	Deg. F
0240	0.11	0.03	14	200	400	33.27 x 125.22	1.31 x 4.93	38.1	1.5	2.5	11	150	300
0340	0.22	0.06	14	200	400	44.50 x 171.45	1.75 x 6.75	50.8	2	5.4	24	150	300
0640	0.57	0.15	14	200	400	56.90 x 224.03	2.24 x 8.82	57.2	2.5	13.6	60	150	300
1340	0.96	0.25	14	200	400	75.44 x 234.95	2.97 x 9.25	76.2	3	22.7	100	150	300
2240	1.97	0.52	14	200	400	98.30 x 279.40	3.87 x 11.00	101.6	4	45.4	200	150	300

Note: Hot clearances required for high temperature operation.



COMPLIANT WITH THE FOLLOWING STANDARDS



ROTARY LOBE PUMPS (RLP)



RLP PRODUCTS:

P.20
STERILOBE

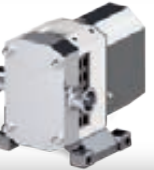

P.22
REVOLUTION®



P.24
CLASSIC+
MULTIPUMP



P.26
RTP



P.28
CONCEPT SQ



BENEFITS

- Broadest industry offering with versatile configurations
- Innovative hygienic designs that meet 3A & EHEDG standards
- Cleanability that fits COP, CIP & SIP processes

PERFORMANCE RANGE

CAPACITY	to 189 m ³ /hr / 832 USGPM
PRESSURE	to 15 BAR / 218 PSI
VISCOSITY	to 440,000 cSt / 2,000,000 SSU
TEMPERATURE	to 150°C / to 300°F

TYPICAL APPLICATIONS



- Gentle handling of shear sensitive liquids, solids handling & fluids containing air or gases
- Optimized efficiency at varying flow rates



SteriLobe

Ideally suited for pharmaceutical & other hygienic applications, the SteriLobe represents significant advancement in the design of rotary lobe pumps. SteriLobe offers breakthrough flexibility in modular design ensuring appropriate configuration is possible for each application.



CLEANABILITY

- Cover joint profile improves hygienic characteristics & self-draining capabilities
- Clean & corrosion resistant stainless gear cover & powder coated bearing housing

PERFORMANCE

- Front loading seals can be changed while the pump is still in-line
- Seal positioned for optimal lubrication, maximizing seal life
- Hassle free gearbox maintenance with sealed for life bearings

EASE OF MAINTENANCE

- Standard bi-wing rotors offer application flexibility & good solids handling capabilities
- Multi-lobe rotors reduce shear & pulsation effect - ideal for sensitive media
- Innovative cusps with reliefs allow for easier cleaning and self draining with improved efficiency



PERFORMANCE RANGE:

- CAPACITY** to 171 m³/hr / 753 USGPM
- PRESSURE** to 15 BAR / 218 PSI
- VISCOSITY** to 200,000 cSt / 910,000 SSU
- TEMPERATURE** to 150°C / 300°F

PORTING OPTIONS:

- Complete range of hygienic clamp, screw, flange & industrial screw connections
- Tri-clamp, flanged, DIN, IMDA, NPT, BSP, etc.

SEAL OPTIONS:

- Single mechanical
- Single mechanical with flush or quench
- Double mechanical with flush
- Complete range of material options

GEARBOX OPTIONS:

- Gear cover & powder coated bearing housing standard
- Stainless steel bearing housing optional

ROTOR & CASING OPTIONS:

- 316L stainless steel pump casing with interior finished to Ra of 24µm (0.6µm)
- Jacketing optional
- 316L stainless steel rotors
- 1.4435 low ferrite stainless steel optional
- Improved surface finishes & electropolishing optional



SteriLobe Model	Displacement		Max Pressure		Max Speed RPM	Standard Ports		Max Capacity		Max Temperature	
	l/rev.	USG/rev.	BAR	PSI		mm	in.	m ³ /hr	USGPM	Deg. C	Deg. F
SLAS	0.039	0.0103	15	218	1400	19	.75	3.18	14	150	300
SLAL	0.059	0.0156	10	145	1400	25	1	5	22	150	300
SLBS	0.081	0.0214	15	218	1200	25	1	5.8	25.7	150	300
SLBL	0.122	0.0322	10	145	1200	38	1.5	8.8	38.7	150	300
SLCS	0.169	0.0446	15	218	1200	38	1.5	12.2	53.6	150	300
SLCL	0.254	0.0671	10	145	1200	50	2	18.3	80.5	150	300
SLDS	0.352	0.093	15	218	1000	38	1.5	20.5	93	150	300
SLDL	0.528	0.1395	10	145	1000	50	2	31.7	139.5	150	300
SLES	0.732	0.1934	15	218	800	50	2	35.1	154.7	150	300
SLEL	1.099	0.2903	10	145	800	76	3	52.8	232.3	150	300
SLFS	1.542	0.4026	15	218	600	76	3	54.8	241.5	150	300
SLFL	2.285	0.6036	10	145	600	101	4	82.3	362.2	150	300
SLGS	3.17	0.8374	15	218	600	101	4	114.1	502.5	150	300
SLGL	4.754	1.2559	10	145	600	152	6	171.1	753.5	150	300

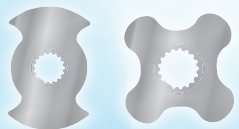

COMPLIANT WITH THE FOLLOWING STANDARDS





The Revolution pump is a continuation of innovation at Wright Flow as the first hybrid rotary lobe & circumferential piston pump with front loading seals. The general purpose lobe pump is a good fit for installations where both lobe & circumferential piston technologies can be used to optimize process efficiency. See for yourself how the bar has been raised on performance & how ease of maintenance has been redefined.

CLEANABILITY

- Efficient CIP (Clean In Place) ability is standard for all Revolution pumps
- Self draining pump head from innovative cusps & cusp reliefs
- Innovative seal design with no dead zones & a dynamic leak path
- No dead zones on front cover

EASE OF MAINTENANCE

- Fast, front loading seal changes while pump is still in-line
- Easy access shimming for setting rotor clearance
- Common spares & identical footprint with Revolution CP pump

PERFORMANCE

- Gentle handling of solids & shear sensitive products
- Long-life durability from heavy duty shafts, bearings & helical gears

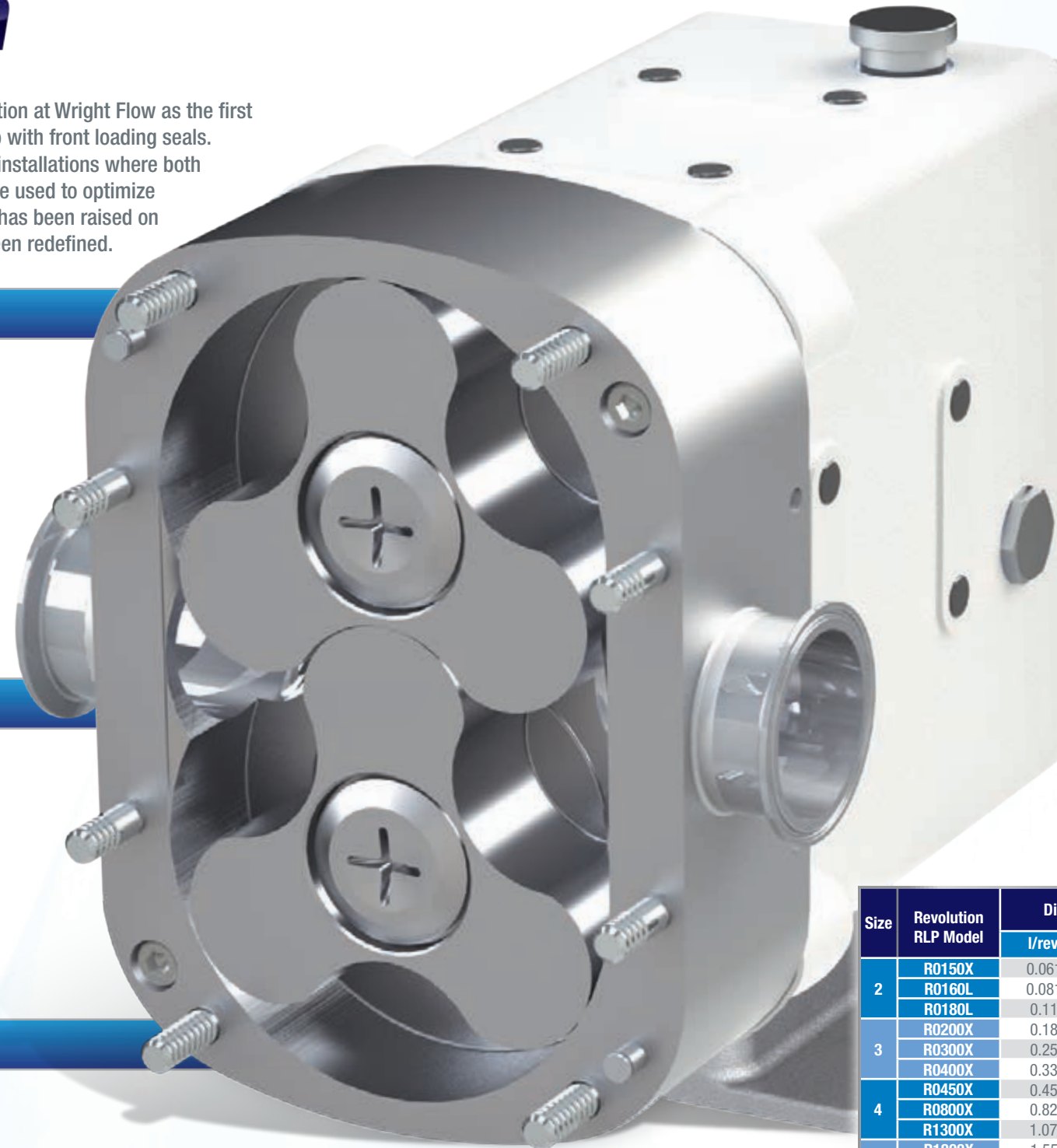

PERFORMANCE RANGE:

- CAPACITY** to 76 m³/hr / 333 USGPM
- PRESSURE** to 15 BAR / 218 PSI
- VISCOSITY** to 440,000 cSt / 2,000,000 SSU
- TEMPERATURE** to 150°C / 300°F

PORTING OPTIONS:

- Hygienic port options: Tri-clamp, DIN 11864, DIN 11851 Male, SMS Male
- Industrial port options: ASA/ANSI 150 lb. or 300 lb. RF, DIN 2633, BSP Male, NPT Male

SEAL OPTIONS:

- Single mechanical
- Double mechanical with flush
- Complete range of material options
- Single O-ring
- Double O-ring with flush

GEARBOX OPTIONS:

- Powder-coated cast iron standard
- Stainless steel optional
- Oil lubrication standard, grease optional

ROTOR & CASING OPTIONS:

- 316L stainless steel pump casing with interior finished to Ra of 32µin (0.8µm)
- 316L stainless steel rotors
- Standard clearance up to 70°C / 158°F
- Optional hot clearance up to 150°C / 300°F
- Pumps may be fitted with front cover & rotor case jackets when required



Size	Revolution RLP Model	Displacement		Max Pressure		Max Speed RPM	Standard Ports		Max Capacity		Max Temperature	
		l/rev.	USG/rev.	BAR	PSI		mm	in.	m ³ /hr	USGPM	Deg. C	Deg. F
2	R0150X	0.061	0.016	15	218	1000	38.1	1.5	3.6	16	150	300
	R0160L	0.081	0.021	10	145	1000	38.1	1.5	4.9	22	150	300
	R0180L	0.11	0.029	7	102	1000	38.1	1.5	6.6	29	150	300
3	R0200X	0.18	0.05	14	203	1000	38.1	1.5	11	47	150	300
	R0300X	0.25	0.07	9	131	1000	38.1	1.5	15	66	150	300
	R0400X	0.33	0.09	7	102	1000	50.8	2	20	86	150	300
4	R0450X	0.45	0.1	15	218	800	50.8	2	22	95	150	300
	R0800X	0.82	0.2	9	131	800	63.5	2.5	39	173	150	300
	R1300X	1.07	0.3	7	102	800	76.2	3	51	226	150	300
5	R1800X	1.55	0.4	15	218	600	76.2	3	56	246	150	300
	R2200X	2.1	0.6	8	116	600	101.6	4	76	333	150	300

Size	Revolution Rectangular Flange Model	Displacement		Max Pressure		Max Speed RPM	Inlet (WxL)		Outlet		Max Capacity		Max Temperature	
		l/rev.	USG/rev.	BAR	PSI		mm	in.	mm	in.	m ³ /hr	USGPM	Deg. C	Deg. F
3	0340	0.23	0.06	17	247	800	47 x 173	1.85 x 6.81	50.8	2	11	48	150	300
4	1340	1	0.3	14	203	600	81 x 236	3.19 x 9.29	76.2	3	36	159	150	300
5	2240	1.98	0.5	21	305	600	103 x 285	4.06 x 11.22	101.6	4	71	313	150	300



COMPLIANT WITH THE FOLLOWING STANDARDS



classic+ MultiPump

As a proven classic, this pump design has endured the test of time. You will find these traditional rotary lobe pumps working reliably around the globe. A simple & economical solution for hygienic processing needs.



CLEANABILITY

- Modular pump design promotes easy disassembly for COP (Clean Out of Place) & CIP (Clean In Place)
- Casing profile cusps maximize efficiency & draining capability

PERFORMANCE

- Timed, non-contacting rotors minimize shear while providing extended run-dry capability
- Helical timing gears provide high torque & quieter operation for extended pump life
- Tapered roller bearings provide higher operating speeds & better discharge pressures

EASE OF MAINTENANCE

- Removable foot for easier placement
- Classic RLP design



COMPLIANT WITH THE FOLLOWING STANDARDS



PERFORMANCE RANGE:

CAPACITY	to 189 m ³ /hr / 832 USGPM
PRESSURE	to 12 BAR / 174 PSI
VISCOSITY	to 200,000 cSt / 910,000 SSU
TEMPERATURE	to 180°C / 355°F

PORTING OPTIONS:

- Complete range of hygienic clamp, screw, flange & industrial screw connections
- Tri-clamp, flanged, DIN, IMDA, NPT, BSP, etc.

SEAL OPTIONS:

- Single O-ring
- Single mechanical
- Single mechanical with flush or quench
- Double mechanical with flush
- Gland packing
- Gland packing with lantern ring with flush
- Complete range of material options

GEARBOX OPTIONS:

- Powder-coated standard

ROTOR & CASING OPTIONS:

- 316L stainless steel pump casing with interior finished to Ra of 32µin (0.8µm)
- 316L stainless steel rotors
- Improved surface finishes & electropolishing optional

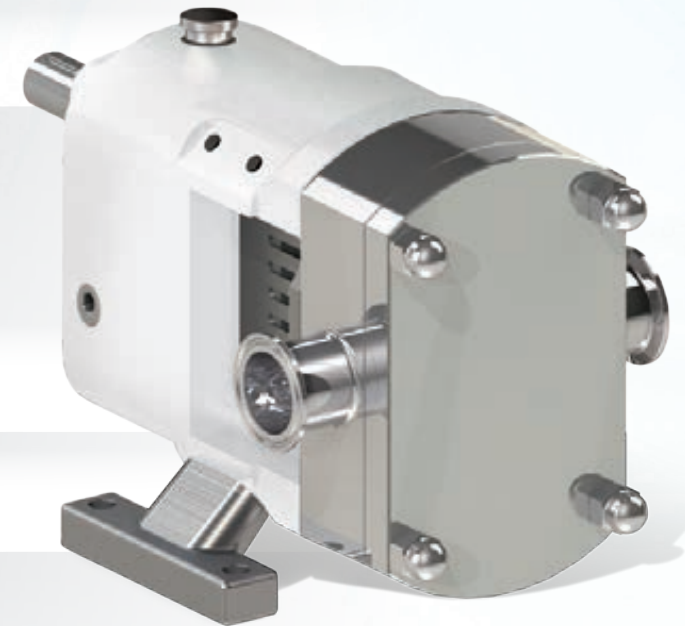

Classic+ MultiPump Model	Displacement		Max Pressure		Max Speed RPM	Standard Ports		Max Capacity		Max Temperature	
	l/rev.	USG/rev.	BAR	PSI		mm	in.	m ³ /hr	USGPM	Deg. C	Deg. F
10/0005/12	0.046	0.0122	12	174	1400	25	1"	3.9	17.1	150	300
10/0008/08	0.083	0.0219	8	115	1400	38	1 1/2"	7	30.7	150	300
10/0011/05	0.111	0.0293	5	70	1400	38	1 1/2"	9.3	41	150	300
20/0020/12	0.202	0.0534	12	174	1000	38	1 1/2"	12.1	53.4	150	300
20/0031/07	0.313	0.0827	7	100	1000	50	2"	18.8	82.7	150	300
30/0069/12	0.694	0.1834	12	174	750	50	2"	31.2	137.6	150	300
30/0113/07	1.125	0.2972	7	100	750	76	3"	50.6	222.9	150	300
40/0180/12	1.8	0.4756	12	174	700	76	3"	75.6	332.9	150	300
40/0250/07	2.5	0.6605	7	100	700	101	4"	105	462.4	150	300
50/0351/12	3.514	0.9284	12	174	650	101	4"	137	603.5	180	355
50/0525/08	5.25	1.387	8	115	600	150	6"	189	832.2	180	355



Designed specifically for the road tanker industry, the RTP series provides higher capacity, higher pressure & unmatched efficiency on a variety of viscosities, enabling faster unloading & loading. This performance, along with advanced durability, application flexibility, ease of installation & ease of maintenance provides a complete solution for your tanker pump needs.

CLEANABILITY

- The simple design behind the rotor sides makes strip cleaning easy and fast
- Choose the cleaning process that fits your needs: COP (Clean Out of Place) or CIP (Clean In Place)

PERFORMANCE

- Easily handles higher viscosity liquids with improved pressure capabilities for faster unloading
- Excellent displacement/weight ratios, meaning more in the tank & less in the cabinet
- Precision helical gears, rotors & shaft design, with optimized bearing position, minimize overhung load – extending seal & bearing life

EASE OF MAINTENANCE

- Innovative front loading seal design enables quick inspection & easy servicing
- Sealed gearcase with long-life lubrication eliminates oil inspection & filling
- Easy to service design requires no special tools for disassembly & eliminates need for end-clearance adjustments

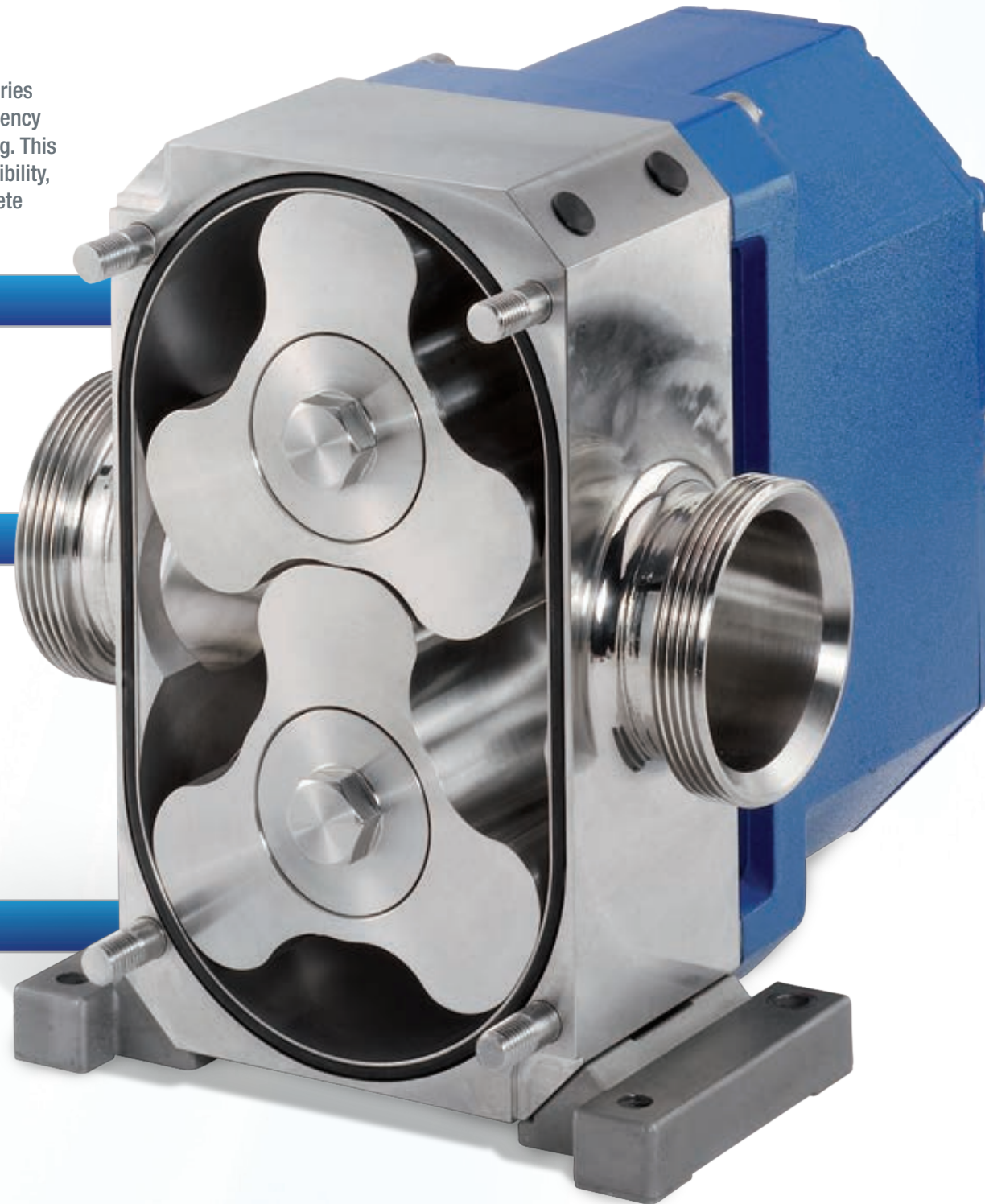

PERFORMANCE RANGE:

- CAPACITY** to 76 m³/hr / 338 USGPM
- PRESSURE** to 12 BAR / 174 PSI
- VISCOSITY** to 200,000 cSt / 910,000 SSU
- TEMPERATURE** to 150°C / 300°F

PORTING OPTIONS:

- Tri-clamp
- ACME
- DIN 11851

SEAL OPTIONS:

- O-ring
- Mechanical seal
- Complete range of material options

GEARBOX OPTIONS:

- Lightweight powder coated aluminum gearbox cover
- SAE 2 & 4 bolt mounting flange for close coupled hydraulic drive applications

ROTOR & CASING OPTIONS:

- 316L stainless steel pump casing with interior finished to Ra of 32µm (0.8µm)
- 316L stainless steel rotors standard
- Pressure relief valve to protect pump against excess pressure spikes optional

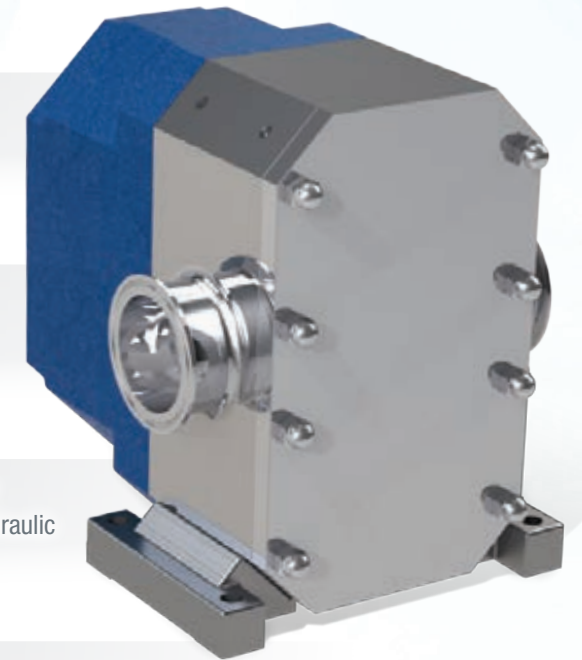

COMPLIANT WITH THE FOLLOWING STANDARDS



RTP Model	Displacement		Max Pressure		Max Speed	Standard Ports		Max Capacity		Max Temperature	
	l/rev.	USG/rev.	BAR	PSI	RPM	mm	in.	m ³ /hr	USGPM	Deg. C	Deg. F
RTP20	1	0.264	10	145	1000	50 or 75	2 or 3	60	264	110	230
RTP30	1.28	0.338	12	174	1000	75 or 100	3 or 4	76.8	338	150	300



Ultra hygienic, ultra gentle product handling for applications requiring superior cleanability including aseptic & sterile process environments. The Concept SQ was designed to eliminate potential product retaining areas in the flow path & to provide the facility for permanent sterile barriers at all product/atmosphere interfaces. The Concept SQ is the benchmark for CIP (Clean In Place) & SIP (Sterilize in Place) process environments.



CLEANABILITY

- Permanent sterile barriers at all product/atmosphere interfaces
- Front cover fitted with controlled compression joint allowing barrier circulation & eliminating inaccessible product-retaining crevices
- Front loading seal design maximizes drainage from the seal area
- Externally retained rotors for optimized cleanability

PERFORMANCE

- Maximum process control for aseptic, sterile or clean process environments
- Uniquely crafted multi-lobe rotors reduce pulsation & ensure gentle product handling

EASE OF MAINTENANCE

- Multi-lobe rotors with internal location & drive are retained from outside the pumping chamber
- Front loading seals positioned directly behind rotors



PERFORMANCE RANGE:

- CAPACITY** to 109 m³/hr / 480 USGPM
- PRESSURE** to 15 BAR / 218 PSI
- VISCOSITY** to 440,000 cSt / 2,000,000 SSU
- TEMPERATURE** to 150°C / 300°F

PORTING OPTIONS:

- Complete range of hygienic clamp, screw, flange & industrial screw connections
- Tri-clamp, hygienic flanged, etc.

SEAL OPTIONS:

- Single mechanical SiC/SiC
- Single mechanical with flush or quench
- Double mechanical with flush
- Complete range of material options

GEARBOX OPTIONS:

- Powder-coated standard
- Stainless steel optional

ROTOR & CASING OPTIONS:

- 316L stainless steel pump casing with interior finished to 3-A standards
- 316L stainless steel rotors standard
- Improved surface finishes & electropolishing optional
- Aseptic options



COMPLIANT WITH THE FOLLOWING STANDARDS



ConceptSQ Model	Displacement		Max Pressure		Max Speed	Standard Ports		Max Capacity		Max Temperature	
	l/rev.	USG/rev.	BAR	PSI	RPM	mm	in.	m ³ /hr	USGPM	Deg. C	Deg. F
SQ1/0004/12	0.04	0.0106	12	175	1000	25	1	2.4	10.6	150	300
SQ1/0007/06	0.07	0.0211	6	85	1000	25	1	4.2	21.1	150	300
SQ2/0017/15	0.17	0.0449	15	218	850	40	1.5	8.67	38.165	150	300
SQ2/0030/07	0.3	0.0793	7	100	850	50	2	15.3	67.405	150	300
SQ3/0054/15	0.54	0.1427	15	218	700	50	2	22.68	99.89	150	300
SQ3/0103/07	1.03	0.2721	7	100	700	80	3	43.26	190.47	150	300
SQ4/0160/15	1.6	0.4227	15	218	600	80	3	57.6	253.62	150	300
SQ4/0303/07	3.03	0.8006	7	100	600	100	4	109.08	480.36	150	300

Pump & Drive Units

FACTORY ASSEMBLED SYSTEMS

Ordering Wright Flow Technologies complete pump & drive units saves time & money. These systems include base plate, motor, couplings, guards, pumps & speed reduction if needed. Close & long coupled styles are available.



EASY SELECTION:

1

CHOOSE YOUR PUMP



2

CHOOSE FROM A STANDARD SELECTION OF WASHDOWN DUTY GEAR MOTORS

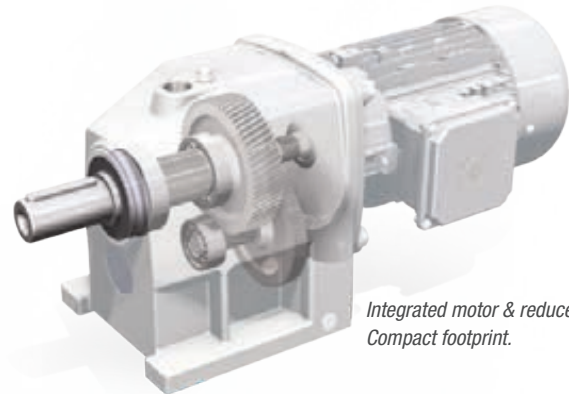

Integrated motor & reducer. Compact footprint.

3

CHOOSE FROM THREE STANDARD UNIT CONFIGURATIONS

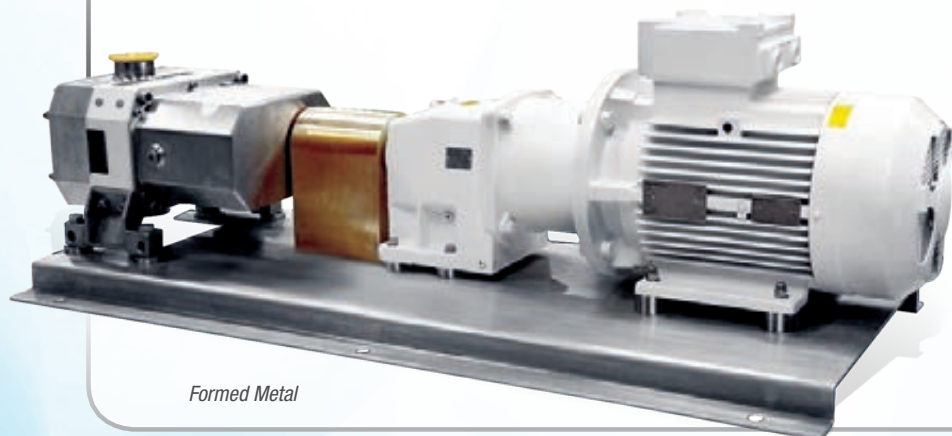

Formed Metal

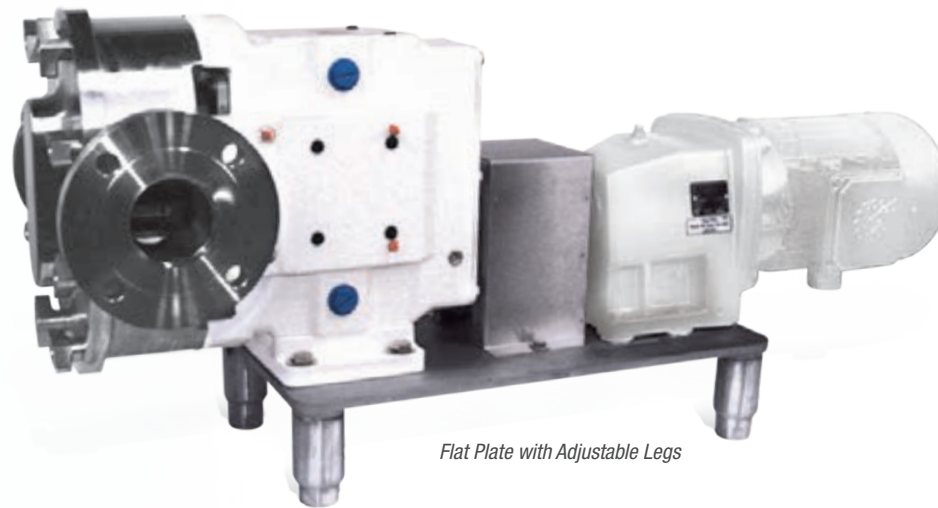

Flat Plate with Adjustable Legs

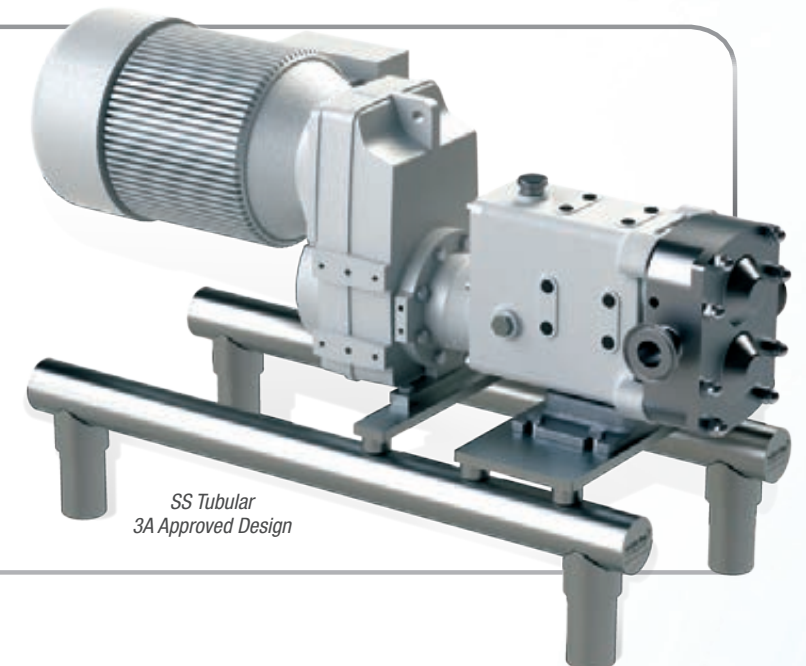

SS Tubular 3A Approved Design

CONVENIENT & COMPLETE

- One stop shop - get your pump & motor from one supplier
- Pre-alignment from factory minimizes final alignment at installation
- Competitive pricing direct through Wright Flow Technologies
- Single source responsibility
- Custom engineered bases to fit customer specifications



CUSTOM CONFIGURATIONS AVAILABLE

- Wright Flow Technologies has a staff of design engineers to fulfill custom requests for complete pump & drive units
- All major brands & types of motors, drives & reducers available
- Special materials & designs; portable & permanent
- Several testing & compliance certification options available

CONTACT YOUR DISTRIBUTOR TO LEARN MORE



Preventive Maintenance Kits

ENSURE TROUBLE-FREE OPERATION & SUPERIOR PERFORMANCE

BENEFITS OF MAINTENANCE KITS:

- Everything you need in one place
- Reduce frequency of repairs
- Increase service life
- Increase uptime
- Save time & money
- Kits include exploded diagram & parts list

SEAL FACE KIT



INCLUDES:

- Seal faces
- Seal seats
- Wave springs
- Packing
- Lubricant

BEARING KIT

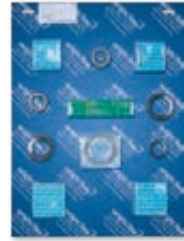

INCLUDES:

- Front bearings
- Rear bearings
- Grease seals
- Oil seals
- Shim kits
- Gear keys
- Gear locknuts & washers
- Spacers

ELASTOMER KIT



INCLUDES:

- Sealing O-rings
- Cover O-rings
- Rotor, retainer / shaft O-rings
- Lubricant

BACK OF MAINTENANCE KIT:

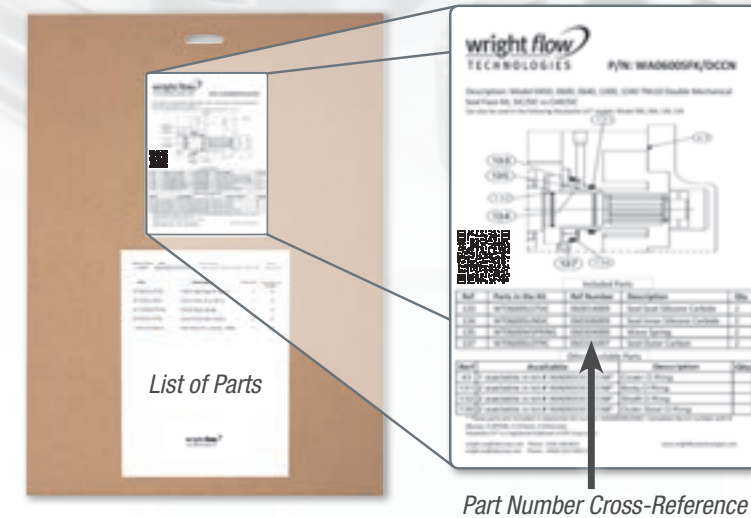

REBUILD VS. REPLACE:

- Wright Flow kits are designed to save time & money, making preventive maintenance & rebuilding easier & more cost-effective
- Wright Flow pumps are designed & built to the highest standards, for long life & to be rebuilt instead of replaced when applicable
- Tool kits also available

Remanufacture & Save!

SIGNIFICANT SAVINGS COMPARED TO PURCHASING NEW

WHY REMANUFACTURE?

- Worn pump is returned to **like-new condition & performance**
- Your remanufactured pump carries a **full 1 year factory warranty**
- All remanufactured pumps are **tested & certified**
- **Save big** compared to purchasing an entirely new pump
- Pumps can be remanufactured **up to four times**, depending on model & wear

WHAT YOU GET:

- NEW ROTORS
- NEW BEARINGS
- NEW SEAL COMPONENTS
- NEW SHAFTS
- NEW GEARS







Wright Flow Technologies offers remanufacturing services for Wright Flow TRA10 & TRA20 Series pumps, as well as upgrading Waukesha® Universal 1 & 2 Series pumps.

Waukesha® & Universal 1 & 2 are the registered trademarks of SPX.

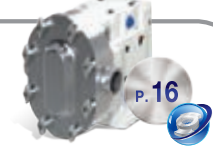
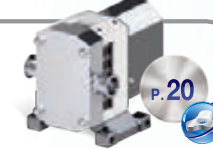

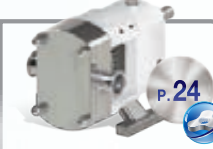
Pump Selection Guide

	 P. 12 Revolution	 P. 14 TRA20SERIES	 P. 16 TRA10SERIES	 P. 20 Sterilabe	 P. 22 Revolution	 P. 24 Classic+ MultiPump	 P. 26 rtp	 P. 28 CONCEPT SQ
✓ PERFORMANCE								
Max Capacity, m ³ /hr	190	102	102	107	76	189	76	109
Max Capacity, USGPM	836	450	450	472	333	832	338	480
Max Pressure, BAR	31	34	27	15	15	12	12	15
Max Pressure, PSI	450	500	400	218	218	174	174	218
Max Viscosity, cSt	440,000	200,000	200,000	200,000	440,000	200,000	200,000	440,000
Max Viscosity, SSU	2,000,000	910,000	910,000	910,000	2,000,000	910,000	910,000	2,000,000
Max Temperature °C	150	150	150	150	150	180	150	150
Max Temperature °F	300	300	300	300	300	355	300	300
✓ SIZES								
Sizes in Series	17	11	9	14	11	11	2	8
✓ CONFIGURATIONS								
Standard	✓	✓	✓	✓	✓	✓	✓	✓
Aseptic	✓	-	✓	-	✓	-	-	✓
Flanged	✓	✓	✓	✓	✓	✓	✓	✓
✓ CERTIFICATIONS								
3-A	✓	✓	✓	✓	✓	✓	✓	✓
EHEDG	✓	-	-	✓	✓	-	-	✓
✓ STANDARDS								
FDA	✓	✓	✓	✓	✓	✓	✓	✓
USDA	✓	✓	✓	✓	✓	✓	✓	✓
CE	✓	✓	✓	✓	✓	✓	✓	✓
ATEX	✓	✓	✓	✓	✓	✓	✓	✓

YOUR COMPLETE *Hygienic Solutions Provider*



wright flow
TECHNOLOGIES[®]

WRIGHT FLOW TECHNOLOGIES, INC.
406 State Street
Cedar Falls, IA 50613 USA
Phone: (319) 268-8013 • E-mail: wright.usa@idexcorp.com

WRIGHT FLOW TECHNOLOGIES LTD.
Highfield Industrial Estate, Edison Road, Eastbourne
East Sussex, United Kingdom, BN23 6PT
Phone: +44(0) 1323 509211 • E-mail: wright.eu@idexcorp.com

WRIGHT FLOW TECHNOLOGIES SUZHOU
Block 6, No. 428 Xing Long Street
Su Chun Industrial Square, Suzhou Industrial Park
Suzhou 215126, China
Phone: 00 86-512-62823000

IDEX FLUID & METERING PVT. LTD.
Survey No. 256, Manjusar GIDC,
Savli, Near Bombardier Circle
Vadodara – 391 770, Gujarat, India
Phone: +91-2667-662001

FOR MORE INFORMATION, CONTACT YOUR LOCAL AUTHORIZED
WRIGHT FLOW TECHNOLOGIES DISTRIBUTOR OR CONTACT US AT:

Distributed By:

WRIGHTFLOWTECHNOLOGIES.COM

